

# Angel







Tub must be set in Mortar Base

### Tub specific options

- |                                   |                       |
|-----------------------------------|-----------------------|
| Microban antibacterial protection | Inline heater         |
| Extra high density fiberglass     | Low voltage LED light |
| Custom jet & pump locations       | Mini spotlights       |
| Plated metallic finish            | Mood light            |
| Additional directional jets       | Grab bars             |
| Swirling, rotating, or jumbo jets | Back masseuse         |
| Micro therapy jet                 | Neck masseuse pillow  |
| Hand held personal massage jet    | HydroOzone            |
| 1½ HP variable speed pump         | Hydro fusion          |
| (temperature display optional)    | Hydro fragrance       |
| Electronic low water protection   | Hydro coat            |
| Cable waste & overflow            |                       |

### Approvals

Commonwealth of Massachusetts

-  Pump motor
-  Jets
-  Anti-vortex suction
-  Overflow location

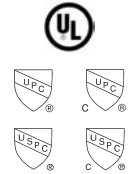
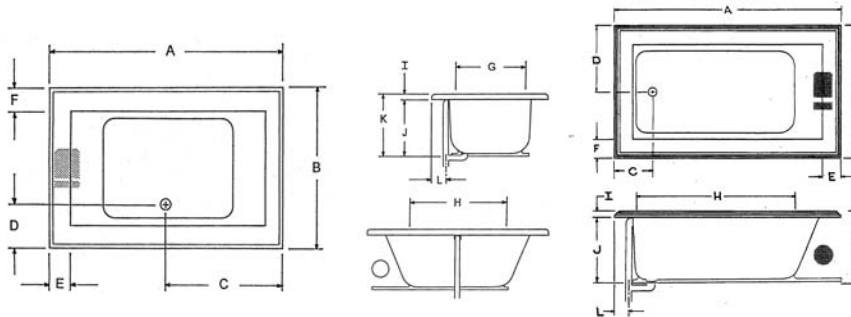

Model	Gel Coat	Acrylic	A	B	C	D	E	F	G	H	I	J	K	L	Jets	Pump H.P.	Water Capacity
6642	N/A	✓	66"	42"	33"	12"	6"	6"	28"	36"	1¾"	20¼"	22"	5"	8	2.25	85 gal.
7242	N/A	✓	72"	42"	36"	12"	6"	6"	28"	42"	1¾"	20¼"	22"	5"	8	2.25	95 gal.
7242 end drain	N/A	✓	72"	42"	12"	21"	6"	6"	28"	50"	1¾"	20¼"	22"	5"	8	2.25	95 gal.
<b>Amps</b>	<b>Volts</b>	<b>Breaker</b>	<b>Dedicated Service</b>														
13.5	115	20 amp	GFCI Protected														

### Framing Dimensions

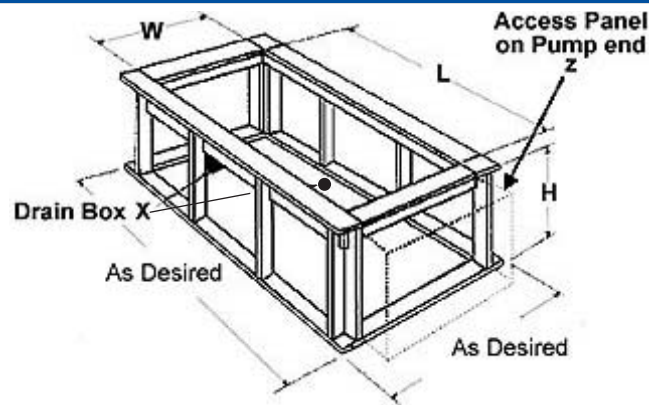

Tub Opening Dimensions			
Model	(L)ength	(W)idth	(H)eight Finish
6642	64"	40"	21¼"
7242	70"	40"	21¼"
7242 end drain	70"	40"	21¼"

All specifications subject to change without notice.