

# SAMUEL HEATH

**Product Number:** P796-C

**Description:** Cupboard knob, 1 1/4" diameter



## Technical information

Knob Ø: 1 1/4"

Projection: 2 1/8"

## Finishes Available



Chrome Plate



Polished Nickel



Non Lacquered  
Brass



City Bronze



Matt Black Chrome



Polished Brass



Satin Nickel



Satin Chrome



Bronze Finish



Antique Brass  
Unlacquered



Brushed Gold  
Gloss



Brushed Gold Matt

## Specification Drawing

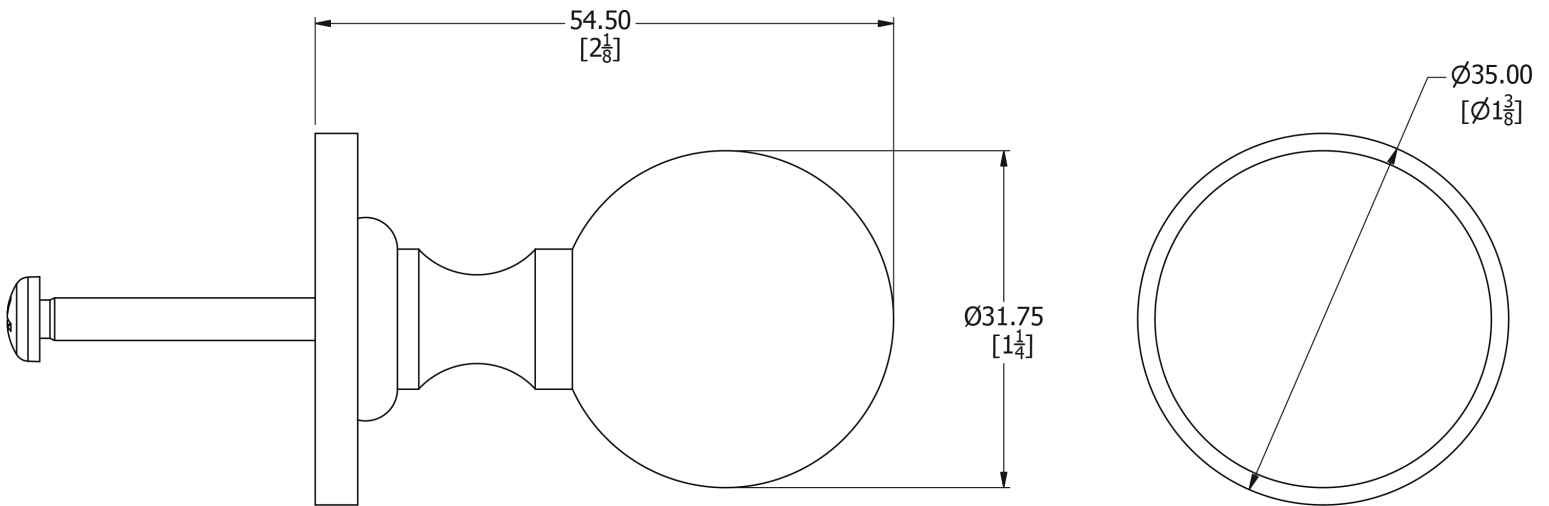

### UK Customer Service

Leopold Street  
Birmingham  
B12 0UJ  
Tel: +44 121 766 4200  
Email: info@samuel-heath.com

### US Customer Service

Federal I.D. No. 58-1504682  
Email: usa@samuel-heath.com

### Specification Enquiries

Design Centre Chelsea Harbour  
1st Floor, North Dome, London  
SW10 0XE  
Tel: 020 7352 0249  
Email: showroom@samuel-heath.com

1-05/09/2019